

A Stabilized Mixed Finite Element Method for Finite Elasticity

Formulation for Linear Displacement and Pressure Interpolation

Ottmar Klaas, Antoinette Maniatty, Mark S. Shephard

Abstract

A stabilized mixed finite element method for finite elasticity is presented. The method circumvents the fulfillment of the Ladyzenskaya-Babuska-Brezzi condition by adding mesh-dependent terms, which are functions of the residuals of the Euler-Lagrange equations, to the usual Galerkin method. The weak form and the linearized weak form are presented in terms of the reference and current configuration. Numerical experiments using a tetrahedral element with linear shape functions for the displacements and for the pressure show that the method successfully yields a stabilized element.

Introduction

Galerkin Methods applied to almost incompressible or fully incompressible finite elasticity in the setting of a mixed Finite Element Method have to fulfill the Ladyzenskaya-Babuska-Brezzi condition to achieve unique solvability, convergence and robustness (see e.g. Brezzi and Fortin [1991]). This imposes severe restrictions on the choice of the solution spaces for the unknowns. Without balancing them properly the solution will show significant oscillations rendering it useless. This prohibits the use of convenient elements that employ equal order shape functions for both, the displacements and the pressure. Furthermore, it makes use of p-adaptive methods impossible since the number of different displacement/pressure combinations for the shape functions is quite general in a p-adaptive environment.

For about 15 years stabilized methods have been used in fluid flows and linear incompressible and nearly incompressible elastic media to overcome most of the limitations in the Galerkin method. Stabilized finite element methods consist of adding mesh-dependent terms to the usual Galerkin methods. Those terms are functions of the residuals of the Euler-Lagrange equations evaluated elementwise. From the construction, it follows that consistency is not affected since the exact solution satisfies both the Galerkin term and the additional term. See e.g. Franca, Hughes, Loula, Miranda [1988] for an application to nearly incompressible linear elasticity, and Hughes, Franca, Balestra [1985] for an application to the Stokes flow, which is a form identical to the incompressible linear elasticity. Douglas and Wang [1989] propose a slightly different stabilization, which they call absolutely stabilized finite element method. Another family of stabilizing techniques consists of constructing LBB stable elements by adding bubble functions to equal-order continuous interpolation elements. Baiocchi, Brezzi, Franca [1993] show that, under certain assumptions, those methods are identical to stabilized methods. Recently Hughes [1995] demonstrated the relationship between stabilized methods and bubble function methods by identifying the origins of those methods in a particular class of subgrid models.

The theoretical and numerical frameworks of finite strain elasticity are well established in the literature. We refer to the works of Green and Zerna [1954], Marsden and Hughes [1983], and Ogden [1984] for details about the theoretical setting, and e.g. Sussmann and Bathe [1987], Simo and Taylor [1991], and Miehe [1994] for the most recent publications on aspects of the development of effective finite element implementations. Brink and Stein [1996] provide a comparison of various mixed methods widely used to solve incompressible and nearly incompressible finite elasticity problems.

This paper's intention is to enhance the idea of stabilized Finite Element methods to finite elasticity. At this point we confine ourselves to stabilizing one particular unstable mixed element, the linear displacement, linear pressure tetrahedral element. This allows testing the efficiency and feasibility of the method without getting into the technical issues of implementations for higher order elements.

This paper is organized as follows: A brief review of a mixed displacement-pressure Finite Element formulations for finite elasticity in both the reference and current configuration is given. The next section introduces the stabilized mixed Finite Element methods obtained by the addition of mesh dependent terms to the usual Galerkin formulation. Based on those ideas a new stable mixed Petrov-Galerkin method in the current and in the reference configuration is developed. Both formulations will be linearized to allow an implementation in a Newton-Raphson scheme. We briefly review appropriate constitutive laws for rubber-like materials before two examples are presented to demonstrate the behavior of the new formulation. Finally, the main conclusions are summarized.

Mixed Displacement-Pressure Formulations

Given a continuum body P we introduce the deformation $\varphi: P \rightarrow \mathfrak{R}^3$ and use the notation $B_o = \varphi_o(P) \subset \mathfrak{R}^3$ for the reference configuration and $B = \varphi(P) \subset \mathfrak{R}^3$ for the current configuration. A point in the reference configuration \mathbf{X} is mapped into a point $\mathbf{x} = \varphi(\mathbf{X}) = \mathbf{X} + \mathbf{u}(\mathbf{X})$ in the spatial configuration where \mathbf{u} denotes the displacement field. We define the deformation gradient $\mathbf{F} = \nabla\varphi(\mathbf{X}) = \mathbf{I} + \nabla\mathbf{u}$ and use the notation $\mathbf{C} = \mathbf{F}^T\mathbf{F}$ for the right Cauchy-Green tensor and $\mathbf{b} = \mathbf{F}\mathbf{F}^T$ for the left Cauchy-Green (or Finger) tensor. The symbols $\nabla[\bullet]$ and $\text{Div}[\bullet]$ denote the gradient and divergence, respectively of a quantity $[\bullet]$ with respect to the coordinates $\mathbf{X} \in B_o$ while we use $\text{grad}[\bullet]$ and $\text{div}[\bullet]$ for the same operators with respect to the coordinates $\mathbf{x} \in B$. We assume hyperelastic, homogeneous material behavior for which a free energy function W , a function of the Cauchy-Green tensor \mathbf{C} , exists, and derive the second Piola-Kirchhoff stress tensor as

$$\mathbf{S} = 2 \frac{\partial W(\mathbf{C})}{\partial \mathbf{C}}. \quad (1)$$

The standard additive decomposition of the stored energy function

$$W = \kappa U(J) + \tilde{W}(\mathbf{C}) \quad (2)$$

into a volumetric part depending only on the Jacobian J of the deformation gradient \mathbf{F} , and a remainder part \tilde{W} is employed throughout the paper. κ denotes the bulk modulus. The decompo-

sition implies that the second Piola-Kirchhoff stress is of the form

$$\mathbf{S} = 2\kappa U'(J) \cdot \frac{\partial J}{\partial \mathbf{C}} + 2 \frac{\partial \tilde{W}(\mathbf{C})}{\partial \mathbf{C}}, \quad (3)$$

where $U'(J) = \partial U(J)/\partial J$ and $\partial J/\partial \mathbf{C} = 1/2 \cdot J\mathbf{C}^{-1}$.

The spatial counterpart of the second Piola Kirchhoff stress tensor is the Cauchy stress tensor $\boldsymbol{\sigma} = J^{-1} \mathbf{F} \mathbf{S} \mathbf{F}^T$ which becomes

$$\begin{aligned} \boldsymbol{\sigma} &= \kappa U'(J) \mathbf{I} + 2J^{-1} \mathbf{F} \frac{\partial \tilde{W}(\mathbf{C})}{\partial \mathbf{C}} \mathbf{F}^T \\ &= \kappa U'(J) \mathbf{I} + J^{-1} \tilde{\boldsymbol{\tau}} \end{aligned} \quad (4)$$

owing to the additive decomposition of the stored energy function. We will refer to $\tilde{\boldsymbol{\tau}}$ as the modified Kirchhoff stress.

In view of the mixed Finite Element formulation we also introduce the quantity

$$p = \kappa U'(J). \quad (5)$$

In the following we present a stabilized mixed displacement-pressure formulation in material quantities defined in the current configuration (Eulerian formulation) and in the reference configuration (Lagrangian formulation). For a more detailed description of the non stabilized formulation see e.g. Brink, Stein [1996].

Eulerian formulation

Described in quantities of the spatial configuration, the boundary value problem of finite elasticity in the absence of body forces is given as:

Find a displacement field \mathbf{u} such that

$$\begin{aligned} -\operatorname{div}[\boldsymbol{\sigma}] &= 0 \quad \text{in } B \\ \boldsymbol{\sigma} \mathbf{n} &= \mathbf{g} \quad \text{on } \Gamma_N \\ \mathbf{u} &= \bar{\mathbf{u}} \quad \text{on } \Gamma_D \end{aligned} \quad (6)$$

\mathbf{n} is the exterior unit normal on Γ , the boundary of B , and \mathbf{g} is a prescribed traction load on part of the boundary Γ_N . We also consider prescribed dirichlet boundary conditions $\bar{\mathbf{u}}$ on Γ_D . Γ_D and Γ_N describe the complete boundary of B , i.e. $\Gamma_D \cup \Gamma_N = \Gamma$ and $\Gamma_D \cap \Gamma_N = \emptyset$.

Multiplying (6)₁ by a weighting function $\tilde{\mathbf{u}}^*$ lying in the space V of kinematically admissible displacements and integrating by parts yields

$$\int_{B_o} \boldsymbol{\tau} : \operatorname{grad} \tilde{\mathbf{u}}^* dV = L_{ext}(\tilde{\mathbf{u}}^*) \quad (7)$$

where

$$L_{ext}(\dot{\mathbf{u}}^*) = \int_{\Gamma_N} \dot{\mathbf{u}}^* \cdot \mathbf{g} da, \quad (8)$$

and $\boldsymbol{\tau} = J\boldsymbol{\sigma}$ is the Kirchoff stress. We treat p as an independent field, and after inserting (4) into (7) and enforcing (5) in a weak sense, the following mixed formulation can be derived:

Find $(\mathbf{u}, p) \in V \times Q$ such that for all $(\dot{\mathbf{u}}^*, \dot{p}^*) \in V \times Q$

$$\begin{aligned} \int_{B_o} \tilde{\boldsymbol{\tau}} : \text{grad } \dot{\mathbf{u}}^* dV + \int_B p \text{div } \dot{\mathbf{u}}^* dv &= L_{ext}(\dot{\mathbf{u}}^*) \\ \int_{B_o} \left(U'(J(\mathbf{u})) - \frac{1}{\kappa} p \right) \dot{p}^* dV &= 0 \end{aligned} \quad (9)$$

Lagrange formulation

Described in quantities of the reference configuration the boundary value problem for finite elasticity in the absence of body forces is given as:

Find a displacement field \mathbf{u} such that

$$\begin{aligned} -\text{Div}[\mathbf{FS}] &= \mathbf{0} \quad \text{in } B_o \\ [\mathbf{FS}]\mathbf{n}_o &= \mathbf{g}_o \quad \text{on } \Gamma_{oN} \quad . \\ \mathbf{u} &= \bar{\mathbf{u}}_o \quad \text{on } \Gamma_{oD} \end{aligned} \quad (10)$$

\mathbf{n}_o is the exterior unit normal on Γ_o , the boundary of B_o , and \mathbf{g}_o is a prescribed traction load on part of the boundary Γ_{oN} . We also consider prescribed dirichlet boundary conditions $\bar{\mathbf{u}}_o$ on Γ_{oD} . Γ_{oD} and Γ_{oN} describe the complete boundary of B_o , i.e. $\Gamma_{oD} \cup \Gamma_{oN} = \Gamma_o$ and $\Gamma_{oD} \cap \Gamma_{oN} = \emptyset$.

Multiplying (10)₁ by a weighting function $\dot{\mathbf{u}}^*$ lying in the space V of kinematically admissible displacements and integrating by parts yields

$$\int_{B_o} \mathbf{S} : [\mathbf{F}^T \nabla \dot{\mathbf{u}}^*] dV = L_{o, ext}(\dot{\mathbf{u}}^*) \quad (11)$$

where

$$L_{o, ext}(\dot{\mathbf{u}}^*) = \int_{\Gamma_{oN}} \dot{\mathbf{u}}^* \cdot \mathbf{g}_o dA. \quad (12)$$

The treatment of p as an independent field gives, after inserting (3) into (11) and enforcing (5) in a weak sense, the following mixed formulation:

Find $(\mathbf{u}, p) \in V \times Q$ such that for all $(\dot{\mathbf{u}}^*, \dot{p}^*) \in V \times Q$

$$\int_{B_o} 2 \frac{\partial}{\partial \mathbf{C}} \tilde{W}(\mathbf{C})(\cdot) : [\mathbf{F}^T \nabla \mathbf{u}^*] dV + \int_{B_o} 2p \frac{\partial}{\partial \mathbf{C}} J(\mathbf{u}) : [\mathbf{F}^T \nabla \mathbf{u}^*] dV = L_{o, ext}(\mathbf{u}^*)$$

$$\int_{B_o} \left(U'(J(\mathbf{u})) - \frac{1}{\kappa} p \right) \mathbf{p}^* dV = 0$$
(13)

Stabilized Finite Element Methods

Stabilized methods are generalized Galerkin methods where terms are added to enhance the stability of the method. Those terms are typically functions of the residuals of the Euler-Lagrange equations multiplied with a differential operator acting on the weight space, and evaluated elementwise. The terms to be added can be written as

$$\sum_{e=1}^{n_{el}} (\mathbf{L}(\mathbf{u}^*, \mathbf{p}^*), \delta(L(\mathbf{u}, p)))_{B^e}$$
(14)

The differential operators \mathbf{L} and L can either be the full differential operator of the problem, as it is done in the Galerkin/least-squares methods (see Hughes, Franca, Hulbert [1989]) or it can be just a part of it. Hughes [1995] has shown that stabilized methods can be derived from fundamental principles if the full differential operator of the problem is taken for \mathbf{L} and L . In a one dimensional linear model problem the operator δ can then be derived as an approximation to an operator emanating from the solution of a Green's function problem on an element (see Hughes [1995] for further details). However, using the full differential operator is rather costly and may not be necessary to achieve a stable and convergent method. In the case of incompressible linear elasticity Hughes, Franca and Balestra [1985] have shown that the part of the differential operator representing the coupling between the pressure and the displacement field (5) does not necessarily have to be included in L or \mathbf{L} . Furthermore, \mathbf{L} only needs to contain the volumetric part of the equilibrium equation. Standard arguments can be employed to obtain the Euler-Lagrange equation from (9):

$$\begin{bmatrix} \mathbf{A} & \mathbf{B} \\ \mathbf{C} & \mathbf{D} \end{bmatrix} \cdot \begin{bmatrix} \mathbf{u} \\ p \end{bmatrix} = \begin{bmatrix} 0 \\ 0 \end{bmatrix},$$

$$L \cdot \begin{bmatrix} \mathbf{u} \\ p \end{bmatrix} = \begin{bmatrix} 0 \\ 0 \end{bmatrix}$$
(15)

where boundary condition terms are omitted. The differential operators \mathbf{D} and \mathbf{B} can be identified as $-1/\kappa$ and grad , respectively. \mathbf{A} and \mathbf{C} are non linear differential operators depending on the actual material law used. Attempting to write them down as a function of \mathbf{u} and p is elusive and does not provide further insight at this point. Following Hughes, Franca and Balestra [1985] we select

$$\mathbf{L} = \begin{bmatrix} 0 & \mathbf{B} \\ 0 & 0 \end{bmatrix}$$
(16)

and

$$L = \begin{bmatrix} A & B \\ 0 & 0 \end{bmatrix} \quad (17)$$

as the differential operators used in the stabilized formulation (14).

Stabilized Eulerian formulation

As already pointed out the differential operator B is given as grad for the Eulerian formulation. We also identify $\mathbf{A}\mathbf{u} + Bp = \text{div}\boldsymbol{\sigma}$. This allows us to write the mesh dependent terms based on (14) as

$$\begin{aligned} \sum_{e=1}^{n_{el}} (\mathbf{L}(\mathbf{u}^*, \dot{p}^*), \delta(L(\mathbf{u}, p)))_{B^e} &= - \sum_{e=1}^{n_{el}} \delta \int_{B^e} \text{div}[\boldsymbol{\sigma}] \cdot \text{grad}\dot{p}^* \, dv \\ &= - \sum_{e=1}^{n_{el}} \delta \left(\int_{B^e} \text{grad } p \cdot \text{grad } \dot{p}^* + \text{div}[J^{-1}\tilde{\boldsymbol{\tau}}] \cdot \text{grad } \dot{p}^* \right) dv \end{aligned} \quad (18)$$

where we made use of the decomposition of the stress tensor (4) together with the representation of the volumetric part of the stress in terms of the quantity p as given in (5). From (18) it can be seen that the method (14) is a residual method, i.e. the additional term will improve the stability of the Galerkin method without compromising the consistency.

The parameter δ is chosen following Hughes, Franca and Balestra [1985] as

$$\delta = \frac{\alpha h^2}{2\mu}, \quad (19)$$

where h is a characteristic element length, and α is a non dimensional, non negative stability parameter depending only on the element type. Recently Hughes [1995] has presented fundamental principles to derive the term $(\alpha h^2)/(2\mu)$ in terms of the elements Green's function for one dimensional problems.

From (9) we arrive at the stabilized mixed finite element form by adding the mesh dependent terms (18):

Find $(\mathbf{u}, p) \in V \times Q$ such that for all $(\mathbf{u}^*, \dot{p}^*) \in V \times Q$

$$\begin{aligned}
& \int_{B_o} \tilde{\tau} : \text{grad } \mathbf{u}^* dV + \int_B p \text{div } \mathbf{u}^* dv = L_{ext}(\mathbf{u}^*) \\
& \int_{B_o} \left(U'(J(\mathbf{u})) - \frac{1}{\kappa} p \right) \dot{p}^* dV - \sum_{e=1}^{n_{el}} \frac{\alpha h^2}{2\mu} \int_{B^e} \text{grad } p \cdot \text{grad } \dot{p}^* dv - \\
& - \sum_{e=1}^{n_{el}} \frac{\alpha h^2}{2\mu} \int_{B^e} \text{div}[J^{-1} \tilde{\tau}] \cdot \text{grad } \dot{p}^* dv = 0
\end{aligned} \tag{20}$$

Note:

- The set of equations (20) can also be derived by multiplying (6)₁ by a modified weighting function $\mathbf{u}^* + ((\alpha h^2)/(2\mu)) \text{grad } \dot{p}^*$, where the perturbation is applied element wise, and following the usual procedure as was partly described in the steps that lead from (6) to (9).

In the following derivations we confine ourselves to elements with linear shape functions for the displacements. This simplifies the equations since the divergence of the stresses will be zero considering that assumption. Accordingly, the weak form (20) reduces to

Find $(\mathbf{u}, p) \in V \times Q$ such that for all $(\mathbf{u}^*, \dot{p}^*) \in V \times Q$

$$\begin{aligned}
& \int_{B_o} \tilde{\tau} : \text{grad } \mathbf{u}^* dV + \int_B p \text{div } \mathbf{u}^* dv = L_{ext}(\mathbf{u}^*) \\
& \int_{B_o} \left(U'(J(\mathbf{u})) - \frac{1}{\kappa} p \right) \dot{p}^* dV - \sum_{e=1}^{n_{el}} \frac{\alpha h^2}{2\mu} \int_{B^e} \text{grad } p \cdot \text{grad } \dot{p}^* dv = 0
\end{aligned} \tag{21}$$

Note:

- The stability parameter is a problem and mesh independent quantity. Once a value has been found that suppresses the stress oscillations no further calibrating for a new mesh or a new problem has to be done. Furthermore, test calculations have shown that the results are not strongly dependent on the stability parameter. Increasing the value even by orders of magnitude does not have a strong impact on the solution.
- The characteristic element length h is optimally chosen as the element length in the direction of the displacement vector. Throughout this paper we assume that the meshes used are rather isotropic in the beginning and that the elements are not distorted to the point that the element size measures have changed dramatically. This allows us to use the maximum edge length as the characteristic element length without further consideration of the displacement vector.

Linearization

We can write equation (21) in short form as

$$\begin{aligned} G_{(u,p)}(\mathbf{u}^*) &= L_{ext}(\mathbf{u}^*) \\ R_{(u,p)}(\mathbf{p}^*) &= 0 \end{aligned} \quad (22)$$

Linearization of (22) leads to the system (see Brink, Stein [1996] for the linearization of the unstabilized equations)

$$\begin{aligned} a_{(u,p)}(\mathbf{u}, \mathbf{u}^*) + b_{(u)}(\mathbf{p}, \mathbf{u}^*) &= L_{ext}(\mathbf{u}^*) - G_{(u,p)}(\mathbf{u}^*) \quad \forall \mathbf{u}^* \in V \\ c_{(u)}(\mathbf{p}, \mathbf{u}^*) + d_{(u)}(\mathbf{p}, \mathbf{p}^*) &= -\bar{R}_{(u,p)}(\mathbf{p}^*) \quad \forall \mathbf{p}^* \in Q \end{aligned} \quad (23)$$

where

$$\begin{aligned} a_{(u,p)}(\mathbf{u}, \mathbf{u}^*) &= D_u[G_{(u,p)}(\mathbf{u}^*)]\mathbf{u} = \int_{B_o} [\text{grad } \mathbf{u}^*]^{sym} : \tilde{e} [\text{grad } \mathbf{u}]^{sym} dV + \int_{B_o} \tilde{\tau} : [\text{grad } \mathbf{u}^{*T} \text{ grad } \mathbf{u}] dV \\ &\quad + \int_B p(\text{div } \mathbf{u} \text{ div } \mathbf{u}^* - \text{grad } \mathbf{u} : \text{grad } \mathbf{u}^{*T}) dV \end{aligned} \quad (24)$$

with the modified fourth-order elastic tangent tensor

$$\tilde{e}^{iklm} = 4F_I^i F_K^k \frac{\partial^2 \tilde{W}}{\partial C_{IK} \partial C_{LM}} F_L^l F_M^m. \quad (25)$$

$$b_{(u)}(\mathbf{p}, \mathbf{u}^*) = D_p[G_{(u,p)}(\mathbf{u}^*)]\mathbf{p} = \int_B \mathbf{p} \text{ div } \mathbf{u}^* dV \quad (26)$$

$$\begin{aligned} c_{(u,p)}(\mathbf{p}, \mathbf{u}^*) &= D_u[R_{(u,p)}(\mathbf{p}^*)]\mathbf{u} = \int_B U''(J) \text{div } \mathbf{u} \mathbf{p}^* dV - \sum_{e=1}^{n_{el}} \frac{\alpha h^2}{2\mu} \int_{B^e} \text{grad } p \cdot \text{grad } \mathbf{p}^* \text{ div } \mathbf{u} dV \\ &\quad - \sum_{e=1}^{n_{el}} \frac{\alpha h^2}{2\mu} \int_{B^e} ((\text{grad } p \cdot (\text{grad } \mathbf{u} \text{ grad } \mathbf{p}^*) + \text{grad } p \cdot (\text{grad } \mathbf{u}^T \text{ grad } \mathbf{p}^*)) dV \end{aligned} \quad (27)$$

$$d_{(u)}(\mathbf{p}, \mathbf{p}^*) = D_p[R_{(u,p)}(\mathbf{p}^*)]\mathbf{p} = - \int_{B_o} \frac{1}{\kappa} \mathbf{p}^* \mathbf{p} dV - \sum_{e=1}^{n_{el}} \frac{\alpha h^2}{2\mu} \int_{B^e} \text{grad } \mathbf{p}^* \cdot \text{grad } \mathbf{p} dV \quad (28)$$

Stabilized Lagrange formulation

As noted earlier we can derive the stabilized weak form starting from the boundary value problem (strong form) by applying the usual steps, but considering a modified weighting function. For the Lagrange formulation we use the pull back of $\text{grad } p = \mathbf{F}^{-T} \nabla p$ to perturbate the Galerkin weighting function. Starting from the strong form (10)₁, multiplying it with the perturbed weighting function $\mathbf{u}^* + ((\alpha h^2)/(2\mu)) \mathbf{F}^{-T} \nabla p^*$, where the perturbation is applied element wise, and inte-

grating it over the domain we get

$$\int_{B_o} \text{Div}[\mathbf{FS}] \cdot \dot{\mathbf{u}}^* dV + \sum_{e=1}^{n_{el}} \frac{\alpha h^2}{2\mu} \int_{B_o^e} \text{Div}[\mathbf{FS}] \cdot (\mathbf{F}^{-T} \nabla \dot{p}^*) dV = 0 \quad (29)$$

The first term in (29) is now integrated by parts, and after introducing the pressure $p = \kappa U'(J(\mathbf{u}))$ as an independent variable, and adding that equation for p we get the standard mixed finite element formulation for finite elasticity (see van den Bogert, de Borst, Luiten and Zeilmaier [1991]) as the first part of the equation (33). We will now focus our attention on the derivation of the stabilization term. Using the additive decomposition of the second Piola-Kirchhoff stress (3) we obtain from the stabilization term in (29)

$$\text{Div}[\mathbf{FS}] = \text{Div}\left[2p\mathbf{F}\frac{\partial J}{\partial \mathbf{C}}\right] + \text{Div}\left[2\mathbf{F}\frac{\partial}{\partial \mathbf{C}}\tilde{W}(\mathbf{C})\right] \quad (30)$$

Without knowledge of the particular material law we can only simplify the first term of (30) as follows

$$\text{Div}\left[2p\mathbf{F}\frac{\partial J}{\partial \mathbf{C}}\right] = \text{Div}[p\mathbf{J}\mathbf{F}\mathbf{C}^{-1}] = \text{Div}[p\mathbf{J}\mathbf{F}^{-T}] = \mathbf{J}\mathbf{F}^{-T}\nabla p \quad (31)$$

where we used $\mathbf{C}^{-1} = \mathbf{F}^{-1}\mathbf{F}^{-T}$ and $(\partial J)/(\partial \mathbf{C}) = 1/2\mathbf{J}\mathbf{C}^{-1}$. The last step in the formulation was achieved by applying the Piola Identity $\text{Div}[\mathbf{J}\mathbf{F}^{-T}] = 0$. By treating the first integral of (29) as given in the equations (10) to (13), substituting (30) and (31) into (29) and realizing that

$$\mathbf{J}\mathbf{F}^{-1}\mathbf{F}^{-T} : [\nabla p \otimes \nabla \dot{p}^*] = \mathbf{J}\mathbf{C}^{-1} : [\nabla p \otimes \nabla \dot{p}^*] = 2\frac{\partial}{\partial \mathbf{C}}J(\mathbf{u}) : [\nabla p \otimes \nabla \dot{p}^*] \quad (32)$$

we are able to define the stabilized mixed weak formulation of (10):

Find $(\mathbf{u}, p) \in V \times Q$ such that for all $(\dot{\mathbf{u}}^*, \dot{p}^*) \in V \times Q$

$$\begin{aligned} & \int_{B_o} 2\frac{\partial}{\partial \mathbf{C}}\tilde{W}(\mathbf{C}) : [\mathbf{F}^T \nabla \dot{\mathbf{u}}^*] dV + \int_{B_o} 2p\frac{\partial}{\partial \mathbf{C}}J(\mathbf{u}) : [\mathbf{F}^T \nabla \dot{\mathbf{u}}^*] dV = L_{ext}(\dot{\mathbf{u}}^*) \\ & \int_{B_o} \left(U'(J(\mathbf{u})) - \frac{1}{\kappa} p \right) \dot{p}^* dV - \sum_{e=1}^{n_{el}} \frac{\alpha h^2}{2\mu} \int_{B_o^e} 2\frac{\partial}{\partial \mathbf{C}}J(\mathbf{u}) : [\nabla p \otimes \nabla \dot{p}^*] dV - \\ & - \sum_{e=1}^{n_{el}} \frac{\alpha h^2}{2\mu} \int_{B_o^e} \text{Div}\left[2\mathbf{F}\frac{\partial}{\partial \mathbf{C}}\tilde{W}(\mathbf{C})\right] \cdot (\mathbf{F}^{-T} \nabla \dot{p}^*) dV = 0 \end{aligned} \quad (33)$$

As for the Eulerian formulation the stabilization term containing the higher order derivatives is zero for elements with linear displacement interpolations.

At this point we would like to point out that the system (33) is consistent with (20) in the sense that pull back or push forward operations, respectively, can be applied to derive one system from

the other. We present the proof for the new terms due to the stabilization as follows while we refer to Brink, Stein [1996] for the proof for the remaining terms. The first stabilization term in (33) can be reformulated using (32)

$$2\frac{\partial}{\partial \mathbf{C}}J(\mathbf{u}):[\nabla p \otimes \nabla \tilde{p}^*] = J\mathbf{F}^{-1}\mathbf{F}^{-T}:[\nabla p \otimes \nabla \tilde{p}^*] = J\mathbf{F}^{-T}\nabla p \cdot \mathbf{F}^{-T}\nabla \tilde{p}^* = J\text{grad} p \cdot \text{grad} \tilde{p}^*. \quad (34)$$

Noticing that

$$\int_{B_o} J\text{grad} p \cdot \text{grad} \tilde{p}^* dV = \int_B \text{grad} p \cdot \text{grad} \tilde{p}^* dv \quad (35)$$

completes the proof for the first term. For the second term we start from the Piola transform

$$2\mathbf{F}\frac{\partial}{\partial \mathbf{C}}\tilde{W}(\mathbf{C}) = J\left\{2J^{-1}\mathbf{F}\frac{\partial \tilde{W}(\mathbf{C})}{\partial \mathbf{C}}\mathbf{F}^T\right\}^*, \quad (36)$$

where $\{ \ }^*$ denotes the Pull Back operator (see Marsden, Hughes [1983]). Then the Piola Identity

$$\begin{aligned} \text{Div}\left[2\mathbf{F}\frac{\partial}{\partial \mathbf{C}}\tilde{W}(\mathbf{C})\right] &= J\text{div}\left[2J^{-1}\mathbf{F}\frac{\partial \tilde{W}(\mathbf{C})}{\partial \mathbf{C}}\mathbf{F}^T\right] \\ &= J\text{div}[J^{-1}\tilde{\boldsymbol{\tau}}] \end{aligned} \quad (37)$$

holds, and using $\mathbf{F}^{-T}\nabla p = \text{grad} p$ completes the proof.

Linearization

We can write equation (33) in abstract form as in (22), and get the linearization as given in (23) with (see e.g. Brink, Stein [1996] for the terms not considering the stabilization)

$$\begin{aligned} a_{(u,p)}(\overset{\Delta}{\mathbf{u}}, \overset{*}{\mathbf{u}}) &= D_u[G_{(u,p)}(\overset{*}{\mathbf{u}})]\overset{\Delta}{\mathbf{u}} = \\ &= \int_{B_o} 4[\mathbf{F}^T\nabla \overset{\Delta}{\mathbf{u}}]^{sym}:\left(\frac{\partial^2}{\partial \mathbf{C}\partial \mathbf{C}}\tilde{W}(\mathbf{C}) + p\frac{\partial^2}{\partial \mathbf{C}\partial \mathbf{C}}J(\mathbf{u})\right)[\mathbf{F}^T\nabla \overset{*}{\mathbf{u}}]^{sym} dV \\ &\quad + \int_{B_o} 2\left(\frac{\partial}{\partial \mathbf{C}}\tilde{W}(\mathbf{C}) + p\frac{\partial}{\partial \mathbf{C}}J(\mathbf{u})\right):[\nabla \overset{\Delta}{\mathbf{u}}^T\nabla \overset{*}{\mathbf{u}}] dV \end{aligned} \quad (38)$$

$$b_{(u)}(\overset{\Delta}{\tilde{p}}, \overset{*}{\mathbf{u}}) = D_p[G_{(u,p)}(\overset{*}{\mathbf{u}})]\overset{\Delta}{\tilde{p}} = \int_{B_o} 2\overset{\Delta}{\tilde{p}}\frac{\partial}{\partial \mathbf{C}}J(\mathbf{u}):[\mathbf{F}^T\nabla \overset{*}{\mathbf{u}}] dV \quad (39)$$

$$\begin{aligned}
c_{(u)}(\hat{\mathbf{p}}, \hat{\mathbf{u}}) &= D_u[R_{(u,p)}(\hat{\mathbf{p}})]\hat{\mathbf{u}} = \int_{B_o} 2\hat{\mathbf{p}}^* U''(J(\mathbf{u})) \frac{\partial}{\partial \mathbf{C}}(J(\mathbf{u})) : [\mathbf{F}^T \nabla \hat{\mathbf{u}}] dV \\
&\quad - \sum_{e=1}^{n_{el}} \frac{\alpha h^2}{2\mu} \int_{B_o^e} 4[\nabla p \otimes \nabla \hat{\mathbf{p}}^*]^{sym} : \frac{\partial^2}{\partial \mathbf{C} \partial \mathbf{C}} J(\mathbf{u}) : [\mathbf{F}^T \nabla \hat{\mathbf{u}}]^{sym} dV
\end{aligned} \tag{40}$$

$$d_{(u)}(\hat{\mathbf{p}}, \hat{\mathbf{p}}) = D_p[R_{(u,p)}(\hat{\mathbf{p}})]\hat{\mathbf{p}} = - \int_{B_o} \frac{1}{\kappa} \hat{\mathbf{p}}^* \hat{\mathbf{p}} dV - \sum_{e=1}^{n_{el}} \frac{\alpha h^2}{2\mu} \int_{B_o^e} 2 \frac{\partial}{\partial \mathbf{C}} J(\mathbf{u}) : [\nabla \hat{\mathbf{p}} \otimes \nabla \hat{\mathbf{p}}^*] dV \tag{41}$$

The second derivative of the Jacobian with respect to the Cauchy-Green strain tensor can be derived as

$$\frac{\partial^2}{\partial \mathbf{C} \partial \mathbf{C}} J(\mathbf{u}) = \frac{1}{2} J \mathbf{\Pi}_{\mathbf{C}^{-1}} + \frac{1}{4} J (\mathbf{C}^{-1} \otimes \mathbf{C}^{-1}) . \tag{42}$$

Here we used the notation $\mathbf{\Pi}_{\mathbf{C}^{-1}}$ for the fourth order tensor $(\partial \mathbf{C}^{-1})/(\partial \mathbf{C})$ which is given in index notation as

$$[\mathbf{\Pi}_{\mathbf{C}^{-1}}]^{ijkl} = -\frac{1}{2} ([\mathbf{C}^{-1}]^{ik} [\mathbf{C}^{-1}]^{jl} + [\mathbf{C}^{-1}]^{il} [\mathbf{C}^{-1}]^{jk}) . \tag{43}$$

Constitutive laws

We consider two different types of Neo-Hooke material models. For both we choose the volumetric contribution to be

$$U(J) = 1/2 \cdot (J - 1)^2 . \tag{44}$$

This is used e.g. by van den Bogert, de Borst, Luiten and Zeilenmaker [1991], and Sussmann and Bathe [1987]. It may be noted that the choice of the volumetric part has no significant impact on the solution in the case of nearly incompressible material. The Jacobian is close to one forcing the contribution of $U(J)$ to be very small since $U(J)$ is assumed to have a minimum at $J = 1$. We use

$$\tilde{W}(\mathbf{C}) = -\mu \ln J + \frac{1}{2} \mu [\text{tr} \mathbf{C} - 3] \tag{45}$$

for the remainder of the free energy function for the first material model. We get

$$2 \frac{\partial}{\partial \mathbf{C}} (\tilde{W}) = -\mu \mathbf{C}^{-1} + \mu \mathbf{I} \tag{46}$$

and

$$2 \frac{\partial^2}{\partial \mathbf{C} \partial \mathbf{C}} (\tilde{W}(\mathbf{C})) = -\mu \mathbf{\Pi}_{\mathbf{C}^{-1}} . \tag{47}$$

The corresponding spatial quantities can be calculated from a push forward operation yielding

$$\tilde{\boldsymbol{\tau}} = \mu[\mathbf{b} - \mathbf{I}], \tilde{\boldsymbol{\varepsilon}} = 2\mu\mathbf{II} \quad (48)$$

with the fourth order identity tensor \mathbf{II} . For nearly incompressible material and large strains the results may deteriorate if \tilde{W} is not purely isochoric. Therefore, in our second material model we choose \tilde{W} to be independent of $J(\mathbf{u})$

$$\tilde{W}(\mathbf{C}) = \frac{1}{2}\mu[J^{-2/3}\text{tr}\mathbf{C} - 3] \quad (49)$$

This results in

$$2\frac{\partial}{\partial\mathbf{C}}\tilde{W} = -\frac{1}{3}\mu J^{-2/3}\text{tr}\mathbf{C}\mathbf{C}^{-1} + \mu J^{-2/3}\mathbf{I} \quad (50)$$

and

$$4\frac{\partial^2}{\partial\mathbf{C}\partial\mathbf{C}}(\tilde{W}(\mathbf{C})) = \frac{2}{3}\mu J^{-2/3}\left(\frac{1}{3}\text{tr}\mathbf{C}(\mathbf{C}^{-1} \otimes \mathbf{C}^{-1}) - (\mathbf{C}^{-1} \otimes \mathbf{I}) - (\mathbf{I} \otimes \mathbf{C}^{-1}) - \text{tr}\mathbf{C}\mathbf{II}_{\mathbf{C}^{-1}}\right) \quad (51)$$

The corresponding spatial quantities are

$$\begin{aligned} \tilde{\boldsymbol{\tau}} &= \mu J^{-2/3}\left[\mathbf{b} - \frac{1}{3}\text{tr}\mathbf{b}\mathbf{I}\right] \\ \tilde{\boldsymbol{\varepsilon}} &= \frac{2}{3}\mu J^{-2/3}\left(\text{tr}\mathbf{C}\mathbf{II} + \frac{1}{3}\text{tr}\mathbf{C}(\mathbf{I} \otimes \mathbf{I}) - (\mathbf{b} \otimes \mathbf{I}) - (\mathbf{I} \otimes \mathbf{b})\right) \end{aligned} \quad (52)$$

Examples

In the following we present two examples to demonstrate the behavior of the stabilized mixed method. All results were computed using the lagrange formulation of equation (33). The stability parameter α was set to 1.0 for all examples.

The results for the unstable method usually deteriorate, and the minimum and maximum values are larger than the values obtained from a stable or stabilized element. The range of the color bar was chosen to allow comparisons between the different calculations (stable, unstable and stabilized method). Element results colored in colors at the extreme spectrum of the color bar, red or dark blue, are therefore not limited by the maximum value of the color bar. We will give the maximum and minimum values for each of the calculations in the text.

Plane strain plate with flat hole

We consider a plane strain plate of 2 by 2 square meter with a flat hole in the center (Figure 1). For the finite element analysis 2538 tetrahedral elements are used to model a quarter of the plate. Symmetry and plane strain boundary conditions are applied. The solution is sought by applying a non zero displacement boundary condition on the top surface stretching the plate by 3%. Neo-Hooke material (49) was chosen and the material parameters were set to $\kappa = 8000\text{N}/\text{m}^2$ and $\mu = 0.8\text{N}/\text{m}^2$.

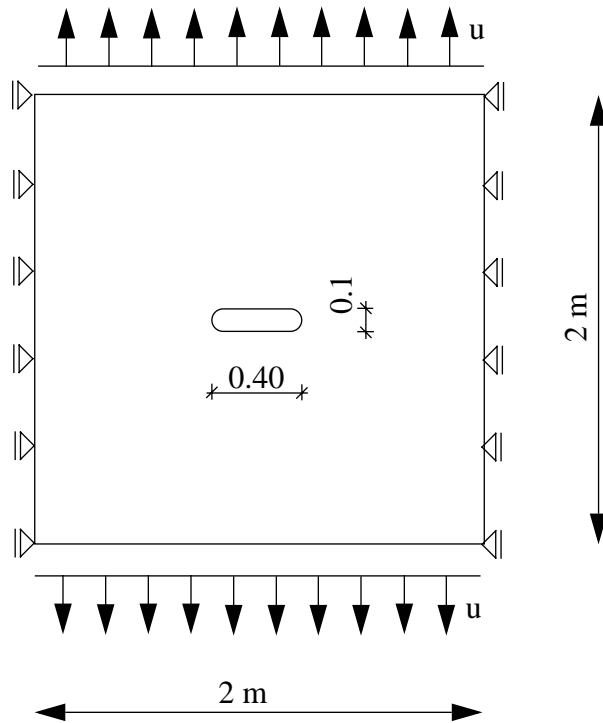

FIGURE 1.: Plane strain plate: System.

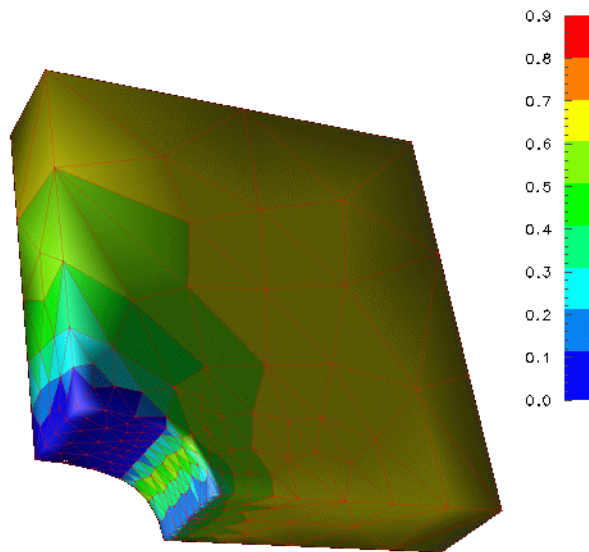

FIGURE 2.: Plane strain plate: Third principal stress. Solution obtained using quadratic shape functions for displacements, linear shapefunctions for pressure.

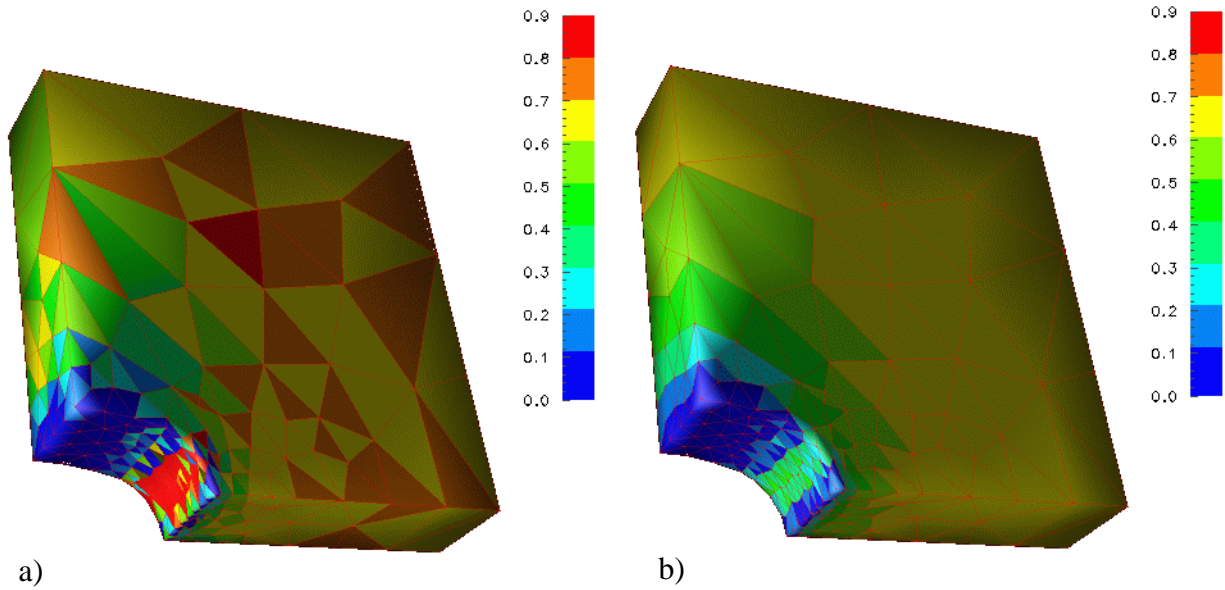

FIGURE 3.: Plane strain plate: Third principal stress. a) Solution obtained with Galerkin method using linear shape functions for displacements and pressure; b) Solution obtained with stabilized Galerkin method using linear shape functions for displacements and pressure.

The third principal stress is plotted for the a priori stable quadratic/linear tetrahedral element in Figure 2. Considering the higher approximation quality of this element compared to the linear/linear tetrahedral element the obtained solution is taken as a reference solution. Figure 3 shows the same result calculated with the linear/linear tetrahedral element. Figure 3 a) presents the solution that was obtained with the mixed Galerkin method without stabilization using linear shape functions for displacements and pressure. The solution differs by a factor of 2 in the area of the stress concentration compared to the reference solution. Furthermore, the stress oscillates all over the domain. The stresses plotted in Figure 3 b) were calculated using the stabilized Galerkin method. Compared to the reference solution, and considering the lower approximation quality of the linear shape functions the results are qualitatively identical. There are no stress oscillations, and the stresses at the stress concentration are a good approximation to the reference solution.

Oscillating stresses similar to Figure 3 a) were also obtained for the first and second principal stresses when the unstabilized Galerkin method was used. Table 1 gives an impression of that behavior by presenting the minimum and maximum values for the principal stresses obtained from the three different calculations. It can be seen that the unstabilized Galerkin method produced rather extreme minimum and maximum values.

Table 1:

		quadratic/ linear	linear/linear	stabilized linear/linear
σ_I	min	0.70	0.52	0.70
	max	3.83	6.53	2.92
σ_{II}	min	0.29	-0.35	0.05
	max	0.84	2.34	0.84
σ_{III}	min	-0.01	-1.44	-0.14
	max	0.67	1.78	0.68

Cook's plane strain problem

This problem has been used by many authors to test element formulations under combined bending and shear (see e.g. Miehe [1994], Brink and Stein [1996]). A tapered panel is clamped on one side while it is loaded with a shear load on the other side, see Figure 4. This problem is treated as a 2 dimensional problem in the literature. For our example the problem was discretized in 3 dimensions, and plane strain boundary conditions were applied on the front and back surface. The problem was discretized with 3464 elements (see Figure 5).

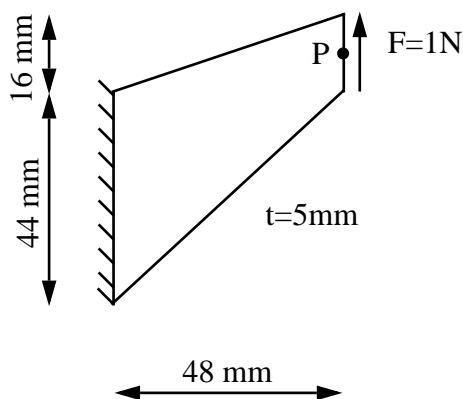

FIGURE 4.: Cook's plane strain problem: System and boundary conditions

We choose the Neo Hooke material (45). The material constants were chosen to $\kappa = 8000\text{ N/mm}^2$ and $\mu = 0.8\text{ N/mm}^2$ which corresponds to a Poisson ratio of $\nu = 0.49995$.

The load was applied in one step, and all formulations needed 5 Newton iterations to reduce the residual by a factor of $1.e-8$.

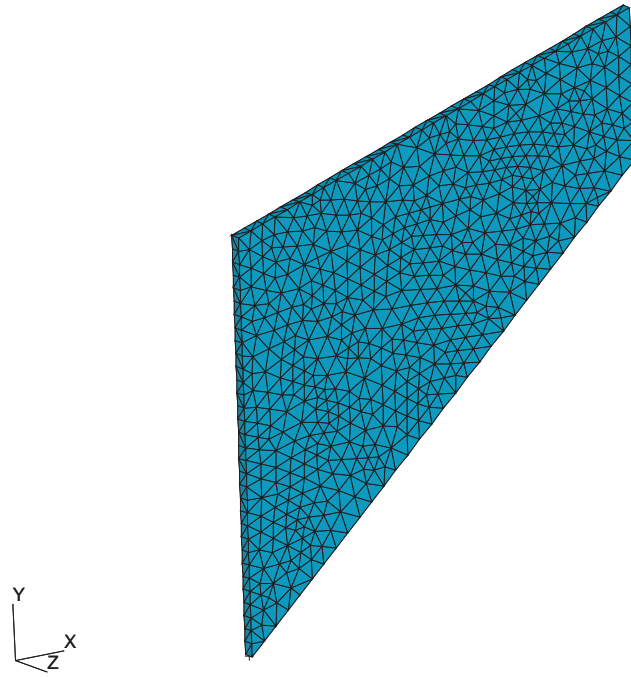

FIGURE 5.: Cook's plane strain problem: Mesh.

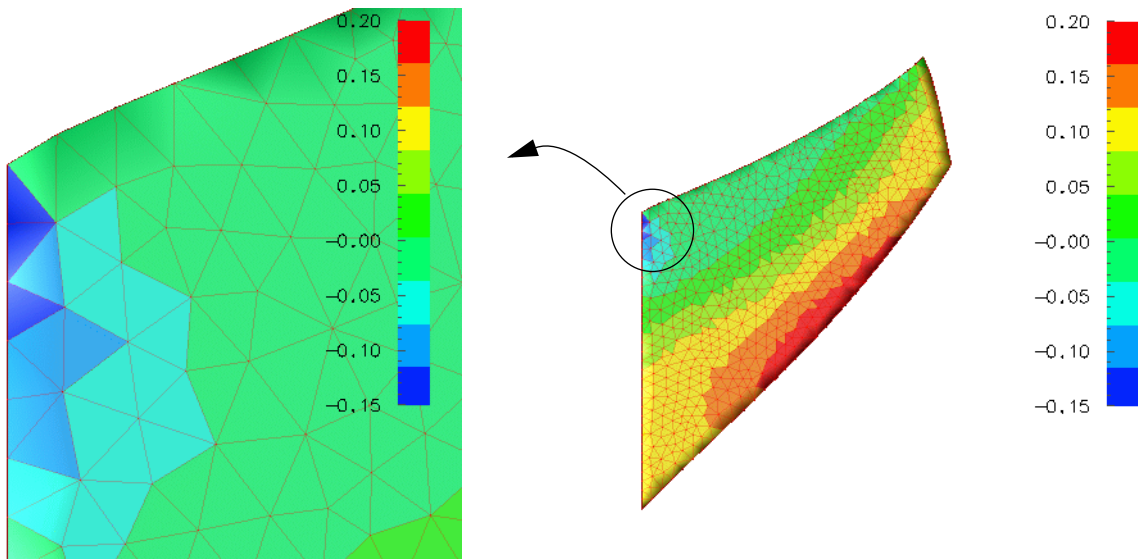

FIGURE 6.: Cook's plane strain problem: First principal stress, quadratic/linear tet element

Figure 6 shows the first principal stress obtained using an element that fulfills a priori the LBB conditions. Quadratic shapefunctions were used for the displacements and linear shapefunctions for the pressure. Once again we use this solution as the reference solution. The top corner displacement was calculated to 7.17 showing very good correspondence to the results given in Brink, Stein [1996]. The stresses are physically meaningful and stress concentrations are captured very

well.

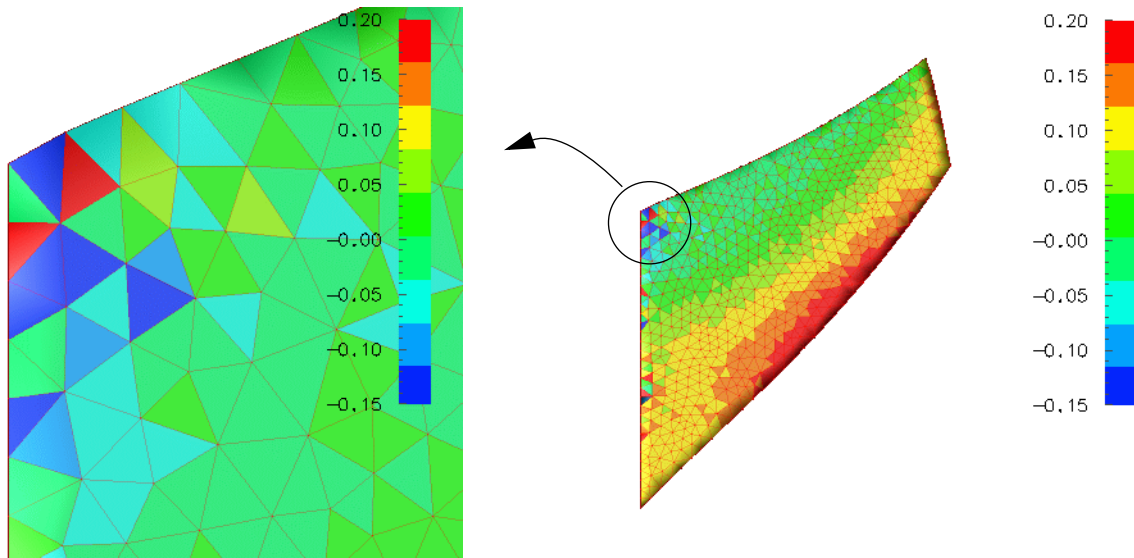

FIGURE 7.: Cook's plane strain problem: First principal stress, linear/linear tetrahedral element.

Figure 7 shows the first principal stress that was obtained using linear shape function for both, the displacements and the pressure. This element does not fulfill the LBB condition, and accordingly it shows severe oscillations in the stress field where the panel is clamped. From the close up given in Figure 7 it can be seen that the stress jumps unphysically from negative to positive values for the first principal stress from element to element.

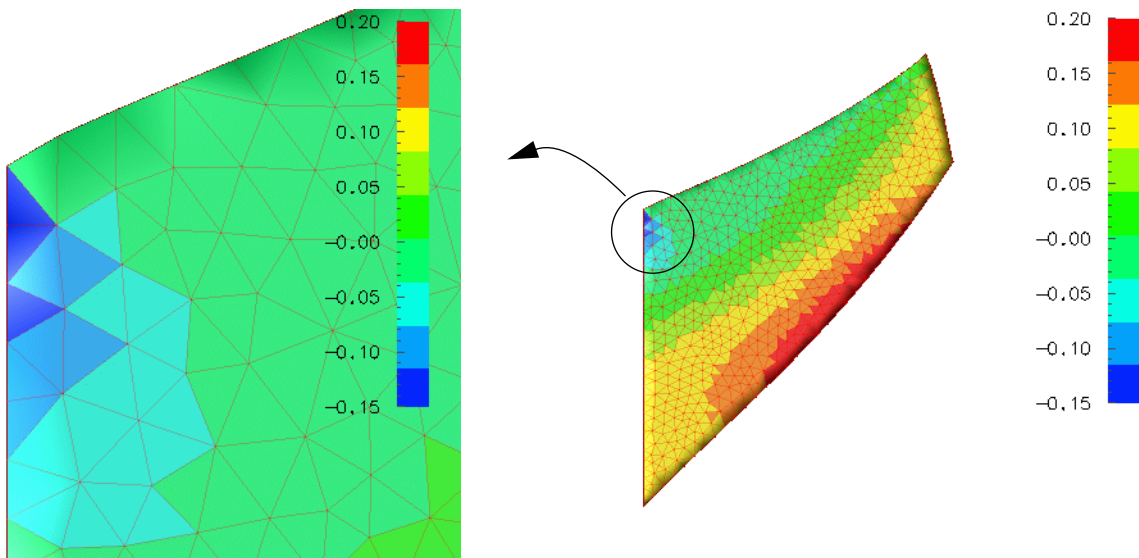

FIGURE 8.: Cook's plane strain problem: First principal stress, stabilized linear/linear tet element.

Figure 8 shows the first principal stress that was obtained using the stabilized element formulation with linear shape functions for the displacement and the pressure. The solution does not show any

oscillations in the stress field. Even though the solution was obtained using only linear shape functions for the displacement the obtained stress field resembles the one obtained using the higher order method very well. The top corner displacement was calculated to 7.09 which is also closer to the result from the higher order method compared to 6.84 computed using the unstable method. Table 2 presents the minimum and maximum values for the principal stresses that were obtained from the different calculations. Once again it can be seen that the results from the stabilized method are always close to the values of the reference solution.

Table 2:

		quadratic/ linear	linear/linear	stabilized linear/linear
σ_I	min	-0.13	-0.96	-0.15
	max	0.19	0.42	0.20
σ_{II}	min	-0.16	-1.06	-0.17
	max	0.09	0.40	0.09
σ_{III}	min	-0.42	-1.09	-0.45
	max	0.03	0.38	0.04

Conclusion

A stabilized mixed finite element method for finite elasticity was presented. Starting from a well known mixed method, mesh dependent terms were added element wise to enhance the stability of the method. The equations for the stabilized method were developed in quantities of the reference configuration, as well as in quantities of the current configuration. Linearization of the weak forms was provided to enable an implementation in a computer code based on the Newton method to solve the system of nonlinear equations. Numerical experiments have shown that the new formulation successfully improves the stability of the linear displacement linear pressure tetrahedral element encouraging further research in this area. We plan to investigate the method for higher order interpolations to facilitate p-methods and to apply the ideas to other type of material models, like e.g. plasticity.

Literature

- [1] Baiocchi, C.; Brezzi, F.; Franca, L.P. (1993): Virtual bubbles and Galerkin-least-squares type methods (Ga.L.S.). *Comp. Meth. Appl. Mech. Engrg.* 105, 125 - 141.
- [2] van den Bogert, P.A.J.; de Borst, R.; Luiten, G.T.; Zeilmaker, J. (1991): Robust finite elements for 3D-analysis of rubber-like materials. *Engrg. Comp.* 8, 3 - 17.
- [3] Brezzi, F.; Fortin, M. (1991): *Mixed and Hybrid Finite Element Methods*. Berlin, Heidelberg, New York: Springer.

- [4] Brink, U.; Stein, E. (1996): On some mixed finite element methods for incompressible and nearly incompressible finite elasticity. *Comp. Mech.* 19, 105 - 119
- [5] Douglas, J.; Wang, J. (1989): An absolutely stabilized finite element method for the Stokes problem. *Math. Comp.* Vol. 52, Number 186, 495 - 508.
- [6] Franca, L.P.; Hughes, T.J.R.; Loula, A.F.D.; Miranda, I. (1988): A new family of stable elements for nearly incompressible elasticity based on a Mixed Petrov-Galerkin finite element method. *Numer. Math.* 53, 123-141
- [7] Green, A.E.; Zerna, W. (1954): *Theoretical Elasticity*, Clarendon Press, Oxford, 1954.
- [8] Hughes, T.J.R. (1995): Multiscale phenomena: Green's functions, the Dirichlet-to-Neumann formulation, subgrid scale models, bubbles and the origins of stabilized methods. *Comp. Meth. Appl. Mech. Engrg.*, 127, 387 - 401.
- [9] Hughes, T.J.R.; Franca, L.P.; Balestra, M. (1985): A new finite element formulation for computational fluid dynamics: V. Circumventing the Babuska-Brezzi condition: A stable Petrov-Galerkin formulation of the stokes problem accommodating equal-order interpolations. *Comp. Meth. Appl. Mech. Engrg.* 59, 85-99.
- [10] Hughes, T.J.R.; Franca, L.P.; Hulbert, G.M. (1989): A new finite element formulation for computational fluid dynamics: VIII. The Galerkin/least-squares method for advective-diffusive equations, *Comput. Meth. Appl. Mech. Engrg.* 73, 173 - 189.
- [11] Marsden, J.E.; Hughes, T.J.R. (1983): *Mathematical Foundations of Elasticity*. Prentice Hall, Englewood Cliffs, N.J.
- [12] Miehe, C. (1994): Aspects of the formulation and finite element implementation of large strain isotropic elasticity. *Int. J. Num. Meth. Engrg.*, 37, 1981 - 2004.
- [13] Ogden, R.W. (1984): *Non-linear Elastic Deformations*. Ellis Horwood, Chichester, 1984.
- [14] Simo, J.C.; Taylor, R.L. (1991): Quasi-incompressible finite elasticity in principal stretches. Continuum basis and numerical algorithms. *Comp. Meth. Appl. Mech. Engrg.* 85, 273 - 310.
- [15] Sussmann, T.; Bathe, K.J. (1987): A finite element formulation for nonlinear incompressible elastic and inelastic analysis. *Comp. Struct.* 26, 357 - 409.